

POOL A

1	VALADIER PICARD Romain (FRA)	33	VALADIER PICARD R. (FRA)
2	DELLO RUSSO Lino Andrea (GER)	34	GONINI S. (ITA)
3	GONINI Simone (ITA)	35	ALZHAN N. (KAZ)
4	ALZHAN Nuradil (KAZ)	36	IGNASIAK K. (POL)
5	IGNASIAK Ksawery (POL)	37	IGNASIAK K. (POL)
6	OVSIIUK Yevhen (UKR)	38	IGNASIAK K. (POL)
7	SILVA Henrique (BRA)	39	SEKIMOTO K. (JPN)
8	WAIZENEGGER Jesse (SUI)	40	SEKIMOTO K. (JPN)
9	SEKIMOTO Kenta (JPN)	41	SEKIMOTO K. (JPN)
10	JAZAN Adam (ISR)	42	JAZAN A. (ISR)
11	DE LUCA Alessio (ITA)	43	JAZAN A. (ISR)
12	VAN DER REE Thom (NED)	44	JAZAN A. (ISR)

POOL B

9	MARKHANBETOV Meray (KAZ)	37	MARKHANBETOV M. (KAZ)
10	ALDAWSARI Abdulrahman (KSA)	38	ANDJELOVIC R. (SRB)
11	ANDJELOVIC Rastko (SRB)	39	AMARASEKARA E. (NOR)
12	AMARASEKARA Egilsten (NOR)	40	AMARASEKARA E. (NOR)
13	KARIMOV Nihat (AUT)	41	SKOMRLJ I. (CRO)
14	SKOMRLJ Ivan (CRO)	42	SKOMRLJ I. (CRO)
15	BEKMURODOV Zamohshari (UZB)	43	BEKMURODOV Z. (UZB)
16	MAZIASHVILI Tornike (GEO)	44	MAZIASHVILI T. (GEO)
17	ZHUBATKAN Nursultan (KAZ)	45	MAZIASHVILI T. (GEO)
18	PARLATI Manuel (ITA)	46	MAZIASHVILI T. (GEO)
19	BLASZCZAK Igor (POL)	47	PARLATI M. (ITA)
20	BOECKER Florian (GER)	48	PARLATI M. (ITA)

POOL C

17	SERIKBAYEV Nurkanat (KAZ)	41	SERIKBAYEV N. (KAZ)
18	CVEK Filip (CRO)	42	KLAUS-STERNWIESER A. (AUT)
19	KLAUS-STERNWIESER Alexa (AUT)	43	DEMPSEY R. (GBR)
20	ROMNAES Marcus (NOR)	44	DEMPSEY R. (GBR)
21	DEMPSEY Ross (GBR)	45	ANDREINI P. (ITA)
22	ANDREINI Pietro (ITA)	46	ANDREINI P. (ITA)
23	AVERSA Simone (ITA)	47	AVERSA S. (ITA)
24	DUESTERDIEK Max (GER)	48	VEKSLER Y. (ISR)
25	VEKSLER Yehonatan (ISR)	49	VEKSLER Y. (ISR)
26	RAKHMETKALI Zhanarys (KAZ)	50	RAKHMETKALI Z. (KAZ)
27	SHIRINOV Nicat (AZE)	51	RAKHMETKALI Z. (KAZ)
28	ANDRAS Norbert Peter (CAN)	52	ANDRAS N. (CAN)

POOL D

25	AUER Marcus (AUT)	45	AUER M. (AUT)
26	CAKAN Enes (TUR)	46	CAKAN E. (TUR)
27	KLEINOS Anton (POL)	47	BURK L. (GER)
28	BURK Lenny Linus (GER)	48	BURK L. (GER)
29	ALRADADI Abdulrahman (KSA)	49	PIPPA A. (ITA)
30	PIPPA Alessandro (ITA)	50	PIPPA A. (ITA)
31	JEAN Enzo (FRA)	51	JEAN E. (FRA)
32	LARKIN Danylo (UKR)	52	SHULMAN A. (ISR)
33	SHULMAN Ariel (ISR)	53	SHULMAN A. (ISR)
34	HRISTOV Hristo (BUL)	54	HRISTOV H. (BUL)
35	FARKAS Bence (HUN)	55	HRISTOV H. (BUL)
36	BISSSEN Zhiger (KAZ)	56	BISSSEN Z. (KAZ)

REPECHAGE

61	SILVA Henrique	65	SILVA Henrique
62	JAZAN Adam	66	ANDJELOVIC Rastko
63	ANDJELOVIC Rastko	67	SKOMRLJ Ivan
64	SKOMRLJ Ivan	68	KLAUS-STERNWIESER Alexander
65	KLAUS-STERNWIESER Alexander	69	ANDREINI Pietro
66	ANDREINI Pietro	70	ANDREINI Pietro
67	ANDREINI Pietro	71	VEKSLER Yehonatan
68	VEKSLER Yehonatan	72	SHULMAN Ariel
69	SHULMAN Ariel	73	SHULMAN Ariel
70	SHULMAN Ariel	74	HRISTOV Hristo
71	HRISTOV Hristo	75	HRISTOV Hristo
72	HRISTOV Hristo	76	AUER Marcus
73	AUER Marcus	77	AUER Marcus
74	AUER Marcus	78	SEKIMOTO Kenta

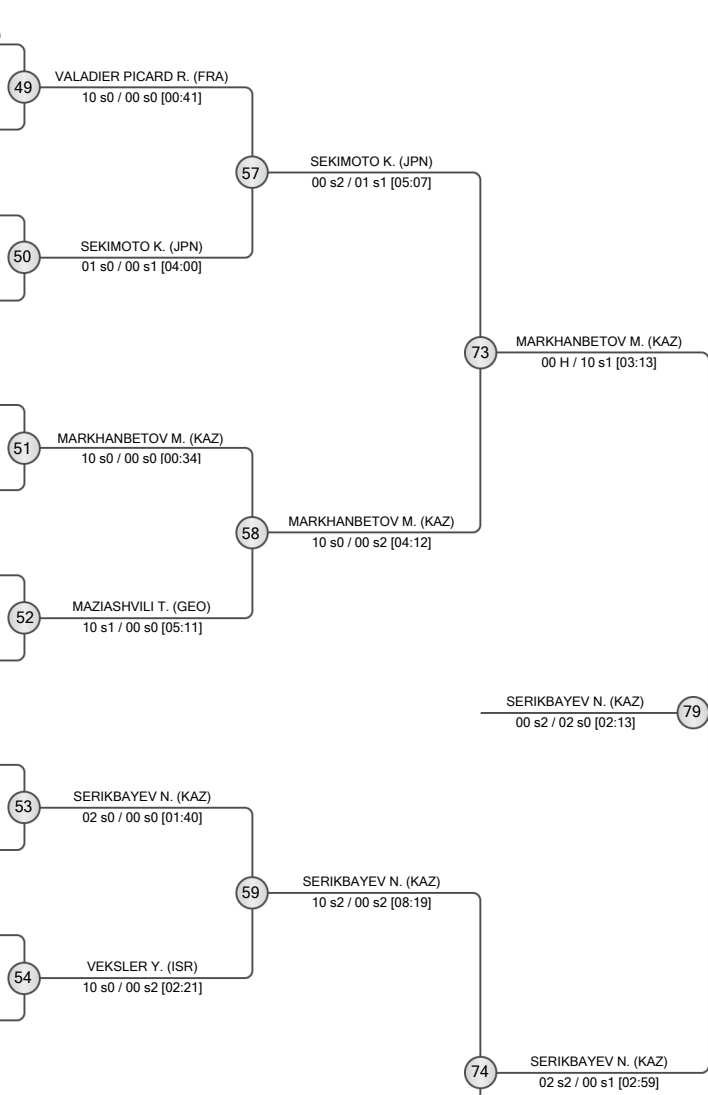

FINAL RESULTS

- SERIKBAYEV Nurkanat (KAZ)
- MARKHANBETOV Meray (KAZ)
- VALADIER PICARD Romain (FRA)
- AUER Marcus (AUT)
- JEAN Enzo (FRA)
- SEKIMOTO Kenta (JPN)
- MAZIASHVILI Tornike (GEO)
- VEKSLER Yehonatan (ISR)



Graz Junior European Cup 2022

Austria, Graz, 4-5 Jun 2022

-66 KG

Men (55)

POOL A

1	ORTIKOV Azizbek	UZB	1	ORTIKOV A. (UZB)	
2	CALDWELL Luke	GBR	33	ORTIKOV A. (UZB)	
3	BRAUNBACH Tiil	GER	00 s1 / 01 s0 [04:00]	10 s0 / 00 s0 [00:20]	
4	BEN SAAD Firas	AUT	3	FURST CRTANEC T. (SLO)	
5	FURST CRTANEC Tobias	SLO	00 s0 / 10 s0 [00:50]	34	DYSHEL D. (ISR)
6	RZAYEV Aydin	AZE	4	DYSHEL D. (ISR)	
7	DYSHEL David	ISR	01 s1 / 10 s1 [02:30]	00 s1 / 10 s0 [02:14]	
8	ZIRAKASHVILI Tenco	GEO	5	ZIRAKASHVILI T. (GEO)	
9	RODRIGUES Paulo	BRA	6	OSMANOV A. (MDA)	
10	OSMANOV ALIM	MDA	00 s1 / 01 s2 [04:29]	35	ZIRAKASHVILI T. (GEO)
11	KALASZ Adam	HUN	7	OSMANOV A. (MDA)	
12	MITSUOKA Gakuto	JPN	00 s2 / 01 s1 [04:00]	36	MITSUOKA G. (JPN)
13	KUNZE Nicolas	GER	8	KUNZE N. (GER)	
14	KOELZER Florian	AUT	11 s0 / 00 s0 [00:35]	10 s0 / 00 H [01:41]	

POOL B

9	BALARJISHVILI Georgios	CYP	9	BALARJISHVILI G. (CYP)	
10	WALDSBERGER Tomas	CZE	37	BALARJISHVILI G. (CYP)	
11	ALQASEM Ibrahim	KSA	02 s1 / 00 s0 [00:36]	51	BALARJISHVILI G. (CYP)
12	SOTIROV Dimitar	BUL	11	ICKES D. (GER)	
13	ICKES David	GER	00 s0 / 10 s0 [00:52]	38	ICKES D. (GER)
14	DE CARDAILLAC Frederic	CAN	12	ANESSOV N. (KAZ)	
15	ANESSOV Nurassyl	KAZ	00 s1 / 10 s1 [01:09]	02 s1 / 01 s1 [04:14]	
16	KOKOLAYEV Ronald	ISR	13	KOKOLAYEV R. (ISR)	
17	MOHYLNYI Davyd	UKR	14	MAERKT L. (GER)	
18	MAERKT Levi	GER	00 s1 / 10 s1 [02:46]	39	KOKOLAYEV R. (ISR)
19	PERITSCH David	AUT	15	LIWOCHA K. (GER)	
20	LIWOCHA Krystian	GER	01 s0 / 10 s0 [02:27]	40	DE LUCA C. (ITA)
21	TOKTAY Davut	TUR	16	DE LUCA C. (ITA)	
22	DE LUCA Ciro	ITA	00 s0 / 10 s0 [00:11]	00 s3 / 11 s0 [03:18]	

POOL C

17	ZAIZAGALIYEV Nursultan	KAZ	17	ZAIZAGALIYEV N. (KAZ)	
18	MRELASHVILI Giga	GEO	18	ZOROTOVIC N. (CRO)	
19	ZOROTOVIC Nikola	CRO	00 s0 / 10 s0 [01:44]	41	ZAIZAGALIYEV N. (KAZ)
20	KOKALJ Gasper	SLO	19	JESIONEK B. (POL)	
21	JESIONEK Bruno	POL	00 s0 / 10 s0 [00:24]	42	HACHEMI Y. (CAN)
22	ZIMMERMANN Marek	GER	20	HACHEMI Y. (CAN)	
23	HACHEMI Yanis	CAN	00 s1 / 11 s0 [00:46]	43	GOMBAS B. (HUN)
24	GOMBAS Balint	HUN	21	GOMBAS B. (HUN)	
25	MENDEL Samuel Ernst	GER	22	SCHIRALDI M. (ITA)	
26	SCHIRALDI Michele	ITA	00 s1 / 01 s0 [04:00]	44	HRISTOV A. (BUL)
27	HRISTOV Alen	BUL	23	HRISTOV A. (BUL)	
28	SEIZ Sebastian	AUT	24	VALIZADA G. (AZE)	
29	VALIZADA Gasim	AZE	00 s0 / 10 s0 [00:43]	44	HRISTOV A. (BUL)

POOL D

25	MOUNDANGA Maxime	FRA	25	MOUNDANGA M. (FRA)
26	DZITAC Ioan	ROU	26	DZITAC I. (ROU)
27	SUGHAYYIR Alhassan	KSA	27	SAFER A. (AUT)
28	SAFER Adam	AUT	28	DEMIREL I. (TUR)
29	ANGERER Robin	GER	29	DEMIREL I. (TUR)
30	DEMIREL Ibrahim	TUR	30	COMERZAN Alexandru
31	COMERZAN Alexandru	ITA	31	KASRADZE A. (GEO)
32	WOESS Julian	AUT	32	KASRADZE A. (GEO)
33	FIKS Eran	ISR	33	FOSTER C. (GBR)
34	FOSTER Cameron	GBR	34	FOSTER C. (GBR)
35	BALTAT Maxim	MDA	35	GABOR A. (HUN)
36	BECKER Viktor	GER	36	GABOR A. (HUN)
37	GABOR Aron	HUN	37	FIKS E. (ISR)
38	WOESS Julian	AUT	38	FIKS E. (ISR)
39	FIKS Eran	ISR	39	FIKS E. (ISR)

REPECHAGE

61	KALASZ A., HUN	61	KALASZ Adam	65	ZIRAKASHVILI Tenco
62	KUNZE N., GER	62	ZIRAKASHVILI Tenco	66	MAERKT Levi
63	MAERKT L., GER	63	MAERKT Levi	67	MAERKT Levi
64	ZOROTOVIC N., CRO	64	DE LUCA Ciro	68	MAERKT Levi
65	SUGHAYYIR A., KSA	65	ZOROTOVIC Nikola	69	MAERKT Levi
66	MOUNDANGA M., FRA	66	HACHEMI Yanis	70	MAERKT Levi
67		67	MOUNDANGA Maxime	71	MAERKT Levi
68		68	DEMIREL Ibrahim	72	MAERKT Levi
69		69		73	MAERKT Levi
70		70		74	MAERKT Levi
71		71		75	MAERKT Levi
72		72		76	MAERKT Levi
73		73		77	MAERKT Levi
74		74		78	MAERKT Levi
75		75		79	MAERKT Levi
76		76		80	MAERKT Levi
77		77		81	MAERKT Levi
78		78		82	MAERKT Levi
79		79		83	MAERKT Levi
80		80		84	MAERKT Levi
81		81		85	MAERKT Levi
82		82		86	MAERKT Levi
83		83		87	MAERKT Levi
84		84		88	MAERKT Levi
85		85		89	MAERKT Levi
86		86		90	MAERKT Levi
87		87		91	MAERKT Levi
88		88		92	MAERKT Levi
89		89		93	MAERKT Levi
90		90		94	MAERKT Levi
91		91		95	MAERKT Levi
92		92		96	MAERKT Levi
93		93		97	MAERKT Levi
94		94		98	MAERKT Levi
95		95		99	MAERKT Levi
96		96		100	MAERKT Levi

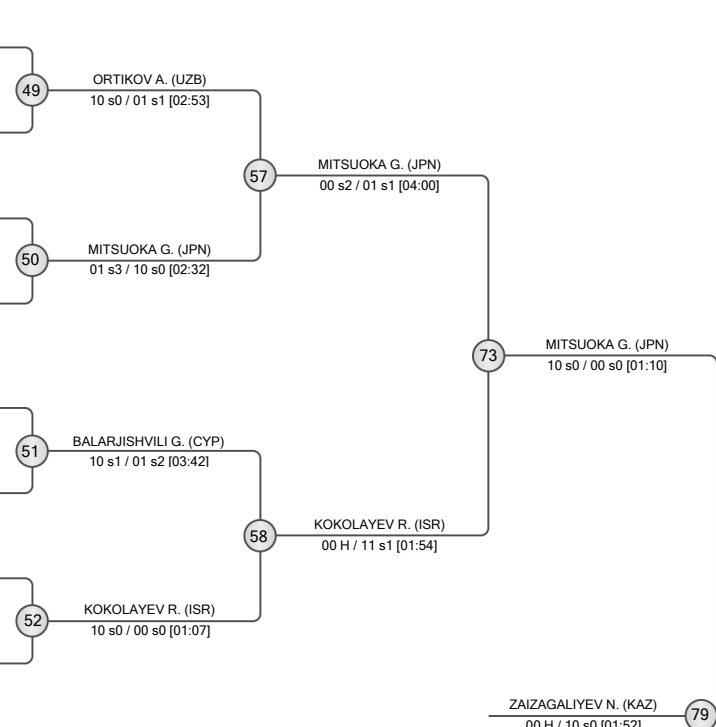

FINAL RESULTS		
1.	ZAIZAGALIYEV Nursultan	KAZ
2.	MITSUOKA Gakuto	JPN
3.	KOKOLAYEV Ronald	ISR
4.	DZITAC Ioan	ROU
5.	GABOR Aron	HUN
6.	ZIRAKASHVILI Tenco	GEO
7.	MAERKT Levi	GER
8.	GOMBAS Balint	HUN





Graz Junior European Cup 2022

Austria, Graz, 4-5 Jun 2022

-73 KG

Men (70)

POOL C

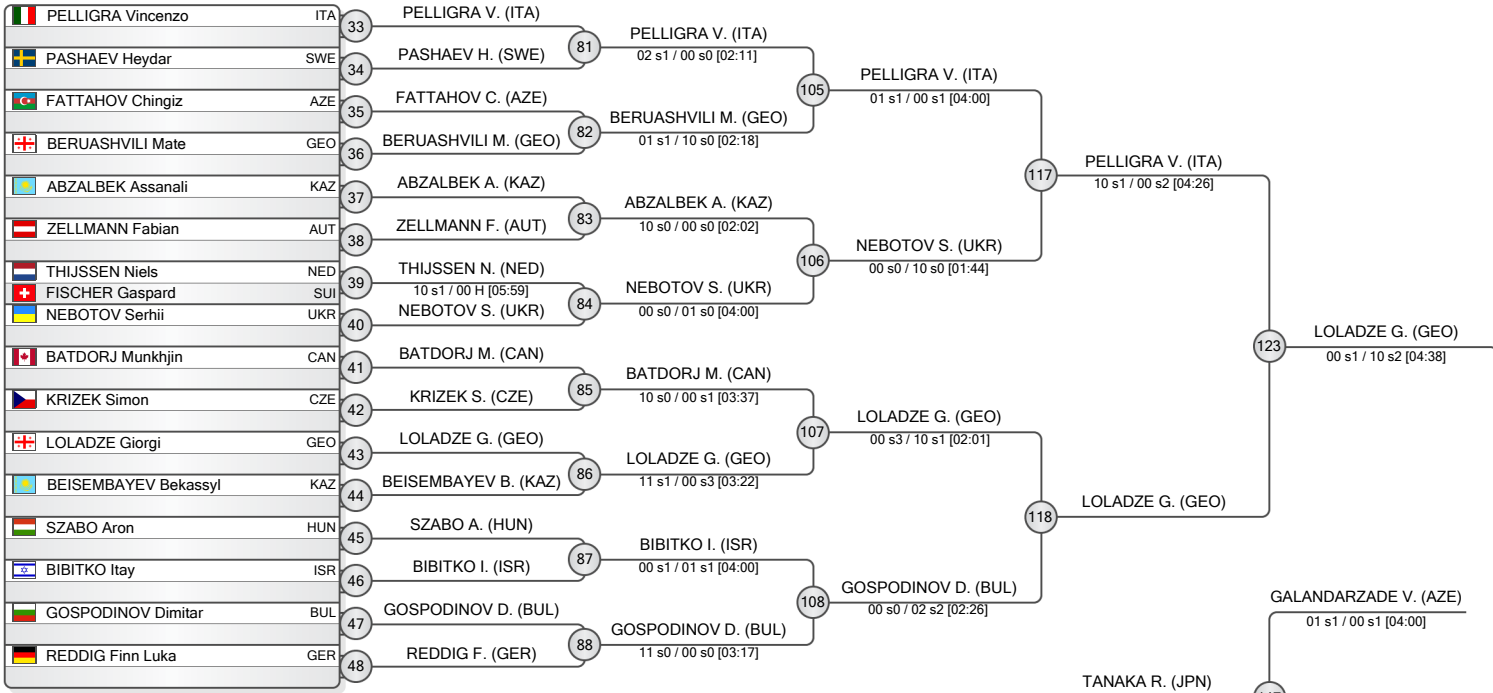

POOL D

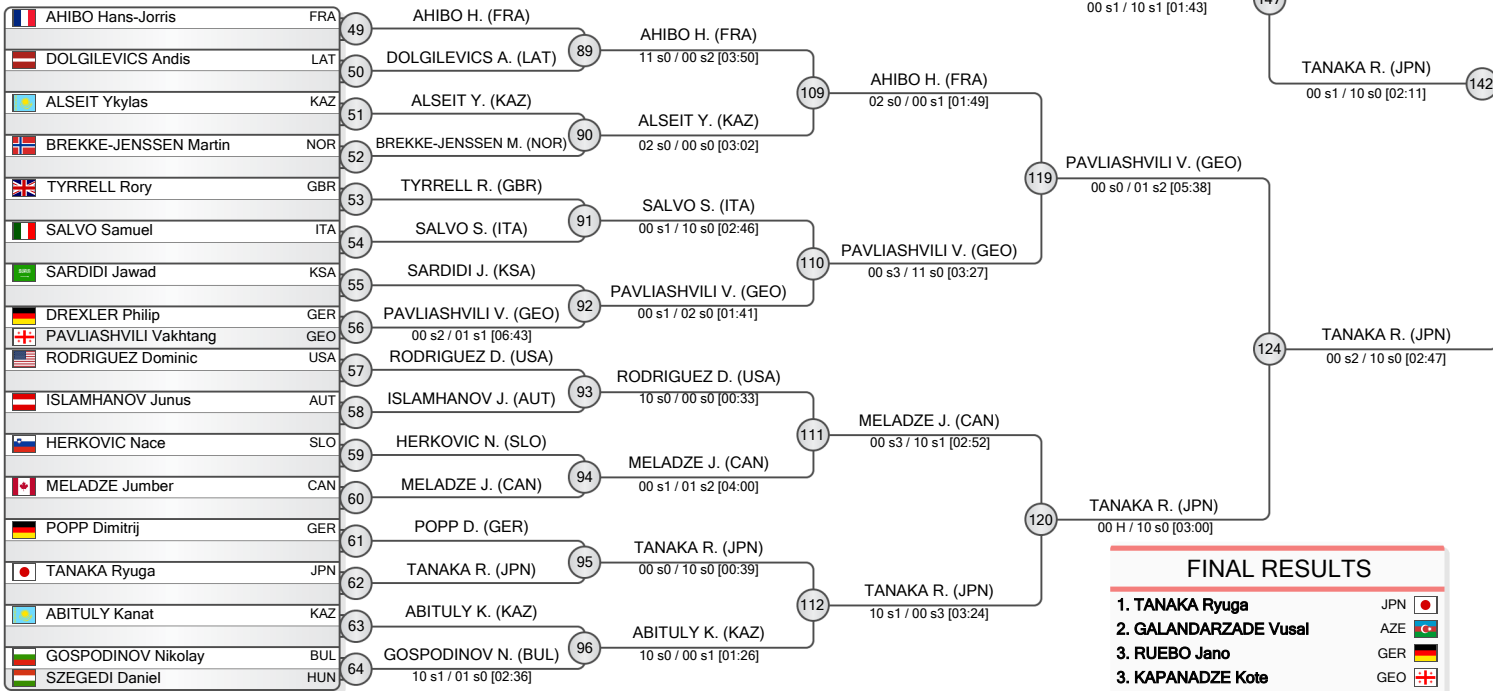

FINAL RESULTS	
1. TANAKA Ryuga	JPN 🇯🇵
2. GALANDARZADE Vusal	AZE 🇦🇿
3. RUEBO Jano	GER 🇩🇪
3. KAPANADZE Kote	GEO 🇬🇪
5. LOLADZE Giorgi	GEO 🇬🇪
5. MELADZE Jumber	CAN 🇨🇦
7. ANDREOU Kyprianos	CYP 🇨🇾
7. PELLIGRA Vincenzo	ITA 🇮🇹

REPECHAGE

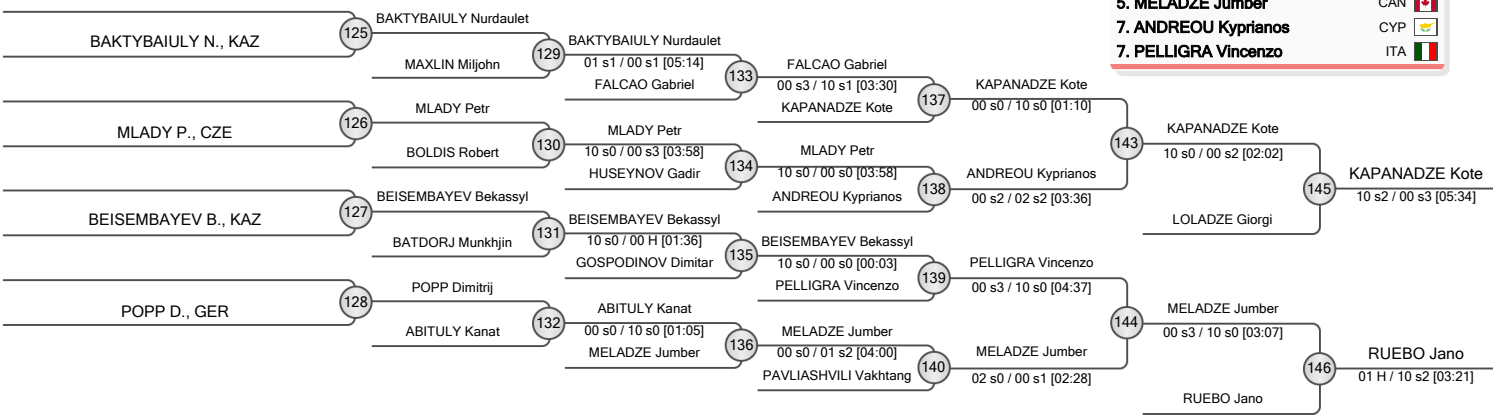

POOL A

1	AREGBA Arnaud (FRA)	33	AREGBA A. (FRA)
2	MIKLOSVOLGYI Daniel (HUN)	34	TAKEICHI D. (JPN)
3	BISSENOV Nurzhan (KAZ)	35	LOLADZE A. (GEO)
4	TAKEICHI Daisuke (JPN)	36	DOMOSZLAI Z. (HUN)
5	ALHAJRI Mohammed (KSA)		
6	SOJKA Alexandr (CZE)		
7	VON SCHRADER Ruben (AUT)		
8	LOLADZE Aleksandre (GEO)		
9	NOOR Rohil (NOR)		
10	ZUBOVIC Stefan (SRB)		
11	VICI Manuel (ITA)		
12	ZOROTOVIC Luka (CRO)		
13	DOMOSZLAI Zolta (HUN)		
14	VALKOV Hristo (BUL)		
15	NOACK Gerrit (GER)		

POOL B

9	MAXIM Meirlan (KAZ)	37	MAXIM M. (KAZ)
10	NICOLAI Hessel (NED)	38	SIMSEK M. (TUR)
11	SCHWARZL Tim (AUT)	39	FASCHING B. (AUT)
12	RAJABLI Omar (AZE)	40	ROTTENSTEIN B. (HUN)
13	COPAK, JR. Gabriel (SVK)		
14	GAULIN Guillaume (CAN)		
15	ROGALSKI Oskar (POL)		
16	SIMSEK Musa (TUR)		
17	LATISEV Mihail (MDA)		
18	FASCHING Bernd (AUT)		
19	YAKOVLEV David (ISR)		
20	BOTHOMÉ Felipe (BRA)		
21	UROSEVIC Aleksandar (GER)		
22	SIKOSEK Gaber (SLO)		
23	HEDENBLAD Joel (SWE)		
24	ROTTENSTEIN Botond (HUN)		

POOL C

17	MURTOZOEV Nurbek (UZB)	41	PICCOLO L. (ITA)
18	TSCHILIKIN Leon (AUT)	42	BADASH I. (ISR)
19	PICCOLO Leonardo (ITA)	43	ZAMANOV I. (AZE)
20	DEMETER Marcell (HUN)	44	JABNIASHVILI G. (GEO)
21	BADASH Iftach (ISR)		
22	DANISMAN Erdal (TUR)		
23	STOBER Urh (SLO)		
24	ZAMANOV Ismayil (AZE)		
25	BORCHASHVILLI Magamed (AUT)		
26	ZEILA Matiss (LAT)		
27	MRKOVIC Lovre (CRO)		
28	KONEV Georgii (BUL)		
29	KAUN Sebastian (GER)		
30	CAMPBELL Logan (GBR)		
31	JABNIASHVILI Giorgi (GEO)		

POOL D

25	DOS SANTOS Kauan (BRA)	45	DOS SANTOS K. (BRA)
26	POPOVICI David (CAN)	46	KAIROLLA Z. (KAZ)
27	DEMETER Bendeguz (HUN)	47	KOSOVIC V. (SRB)
28	MAIMANI Abdulraouf (KSA)	48	BORZECKI B. (POL)
29	OHNEISER Lukas (GER)		
30	OHNEISER Lukas (GER)		
31	BARDUS Iacopo (ITA)		
32	RAUCH Oliver (AUT)		
33	KAIROLLA Zhalgas (KAZ)		
34	IMAMVERDIEV Magerram (AZE)		
35	GULBIANI Alexandre (GEO)		
36	GEROSA Loic (SUI)		
37	KOSOVIC Velimir (SRB)		
38	BORZECKI Bartosz (POL)		
39	ELEFTHERIADIS Spiros (FRA)		
40	LEONTIEV Vadym (UKR)		
41	MARUSKA Alex (SVK)		

REPECHAGE

61	ALHAJRI M., KSA	65	AREGBA Arnaud
62	SOJKA A., CZE	66	RAJABLI Omar
63	NICOLAI H., NED	67	ZAMANOV Ismayil
64	RAJABLI O., AZE	68	KOSOVIC Velimir
65	CAMPBELL L., GBR		
66	KAUN S., GER		
67	ELEFTHERIADIS S., FRA		
68	MARUSKA A., SVK		

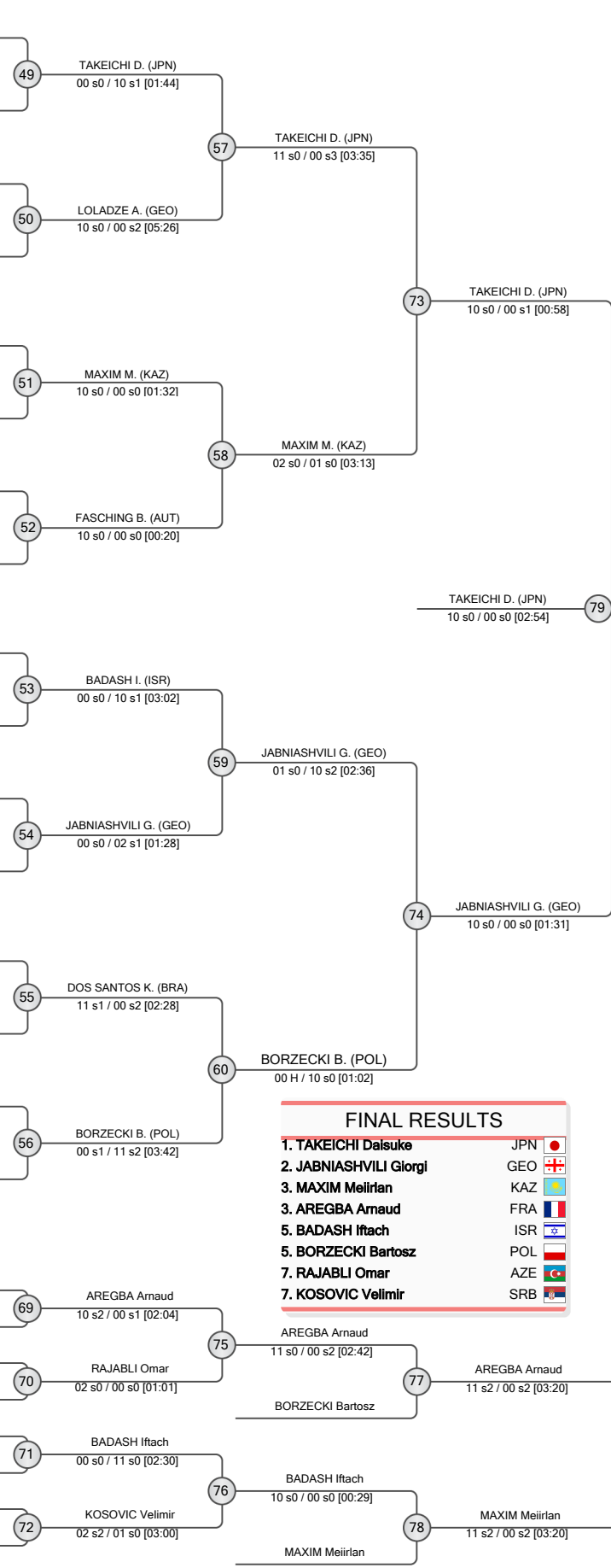

FINAL RESULTS		
1.	TAKEICHI Daisuke	JPN
2.	JABNIASHVILI Giorgi	GEO
3.	MAXIM Meirlan	KAZ
5.	AREGBA Arnaud	FRA
5.	BADASH Iftach	ISR
5.	BORZECKI Bartosz	POL
7.	RAJABLI Omar	AZE
7.	KOSOVIC Velimir	SRB

POOL A

1	TALIBOV Vugar	AZE	TALIBOV V. (AZE)	33	TALIBOV V. (AZE)
2	OMELCHENKO Bohdan	UKR	GUGUNASHVILI G. (GEO)	00 s1 / 10 s0 [00:38]	02 s1 / 01 s0 [03:17]
3	GUGUNASHVILI Gizo	GEO	GARAND A. (CAN)	34	DOSSYMOV K. (KAZ)
4	GARAND Alec	CAN	DOSSYMOV K. (KAZ)	00 s1 / 10 s2 [02:34]	00 s1 / 10 s0 [00:13]
5	DEMIRTAS Cem	TUR	VAN HERK I. (NED)	5	VAN HERK I. (NED)
6	DOSSYMOV Kudyret	KAZ	RAFFAELI A. (ITA)	35	RAFFAELI A. (ITA)
7	VAN HERK Ian	NED	RAFFAELI A. (ITA)	00 s0 / 02 s0 [02:36]	01 s3 / 10 s2 [03:24]
8	TEPELMANN Yves Maurice	GER	KAVNIK V. (SLO)	7	KAVNIK V. (SLO)
	RAFFAELI Andrea	ITA	REIMETS G. (EST)	36	KAVNIK V. (SLO)
	KAVNIK Vid	SLO			10 s0 / 00 s0 [01:56]
	REIMETS Georg	EST			

POOL B

9	POLADISHVILI Tornike	GEO	POLADISHVILI T. (GEO)	37	POLADISHVILI T. (GEO)
10	ERLER Maximilian	GER	HRIBAR A. (SLO)	01 s0 / 02 s0 [04:26]	02 s0 / 00 s0 [00:40]
11	HRIBAR Anej	SLO	FAVA T. (ITA)	11	FAVA T. (ITA)
12	FAVA Tommaso	ITA	VLADOV B. (BUL)	38	VLADOV B. (BUL)
13	VLADOV Borislav	BUL	VLADOV B. (BUL)	00 s1 / 10 s2 [02:40]	00 s1 / 10 s2 [02:40]
14	PAPOYAN Aslan	AUT	PAPOYAN A. (AUT)	13	PAPOYAN A. (AUT)
15	MANDIC Vojin	SRB	PAPOYAN A. (AUT)	39	PAPOYAN A. (AUT)
16	SALVADOR MASSO Oriol	ESP	PAPOYAN A. (AUT)	02 s1 / 00 s0 [01:34]	02 s1 / 00 s0 [01:34]
	BONGIORNO Emilio Tindaro	ITA	BONGIORNO E. (ITA)	15	BONGIORNO E. (ITA)
	ALI David	FRA	ALI D. (FRA)	40	ALI D. (FRA)
					00 s0 / 02 s2 [01:10]

POOL C

17	MORAIS Guilherme	BRA	MORAIS G. (BRA)	41	MORAIS G. (BRA)
18	CLOCCHIATTI Daniel	ITA	CLOCCHIATTI D. (ITA)	10 s0 / 00 s0 [00:44]	10 s0 / 00 s0 [00:44]
19	ALMALKI Osama	KSA	ALMALKI O. (KSA)	42	MITROVIC A. (FRA)
20	MITROVIC Aleksa	FRA	MITROVIC A. (FRA)	00 s0 / 10 s0 [00:46]	00 s0 / 10 s0 [00:46]
21	HEEREN Axel	NED	ARAPOV A. (KAZ)	21	ARAPOV A. (KAZ)
22	ARAPOV Aidar	KAZ	ARAPOV A. (KAZ)	21	ARAPOV A. (KAZ)
23	DUINOVS Maksims	LAT	JAPARIDZE A. (GEO)	43	JAPARIDZE A. (GEO)
24	JAPARIDZE Akaki	GEO	JAPARIDZE A. (GEO)	00 s3 / 10 s2 [03:35]	00 s3 / 10 s2 [03:35]
25	KIELESINSKI Jakub	POL	KIELESINSKI J. (POL)	23	KIELESINSKI J. (POL)
26	SAMMARTINO Gabriele	ITA	SAMMARTINO G. (ITA)	44	KIELESINSKI J. (POL)
					10 s0 / 00 s0 [00:59]

POOL D

25	SIVAN Roy	ISR	SIVAN R. (ISR)	45	SIVAN R. (ISR)
26	SCHRIEVER Lasse	GER	SCHRIEVER L. (GER)	02 s0 / 00 s0 [00:38]	10 s0 / 00 s0 [02:32]
27	ALACSONY Bator	HUN	BLOESCH M. (SUI)	27	BLOESCH M. (SUI)
28	BLOESCH Morgan	SUI	LHOTZKY F. (CZE)	46	LHOTZKY F. (CZE)
29	LHOTZKY Frantisek	CZE	LHOTZKY F. (CZE)	11 s0 / 00 s1 [02:59]	00 s1 / 10 s1 [03:35]
30	HATZMANN Alexander	AUT	MAMATRAKHIMOV J. (UZB)	29	MAMATRAKHIMOV J. (UZB)
31	MAMATRAKHIMOV Jakhongir	UZB	MAMATRAKHIMOV J. (UZB)	47	MAMATRAKHIMOV J. (UZB)
32	MAMULASHVILI Archil	GEO	MAMULASHVILI A. (GEO)	30	MAMULASHVILI A. (GEO)
33	MUKASHEV Bekbol	KAZ	MUKASHEV B. (KAZ)	31	MUKASHEV B. (KAZ)
34	PURNAT Nik	SLO	PURNAT N. (SLO)	48	PURNAT N. (SLO)
35	CHIROSCA Matei	ITA	PURNAT N. (SLO)	02 s0 / 00 s2 [03:40]	00 s3 / 10 s1 [02:35]

REPECHAGE

61	GUGUNASHVILI Gizo	65	DOSSYMOV Kudyret	69	GUGUNASHVILI Gizo
			RAFFAELI Andrea		02 s1 / 00 s1 [01:35]
62	MANDIC Vojin	66	ALI David	70	POLADISHVILI Tornike
			POLADISHVILI Tornike		00 s1 / 10 s2 [03:47]
63	HEEREN Axel	67	HEEREN Axel	71	JAPARIDZE Akaki
			MORAIS Guilherme		00 s2 / 02 s1 [02:24]
64	MAMULASHVILI Archil	68	PURNAT Nik	72	SIVAN Roy
			PURNAT Nik		00 s3 / 10 s2 [05:11]
			SIVAN Roy		00 s3 / 10 s1 [03:36]

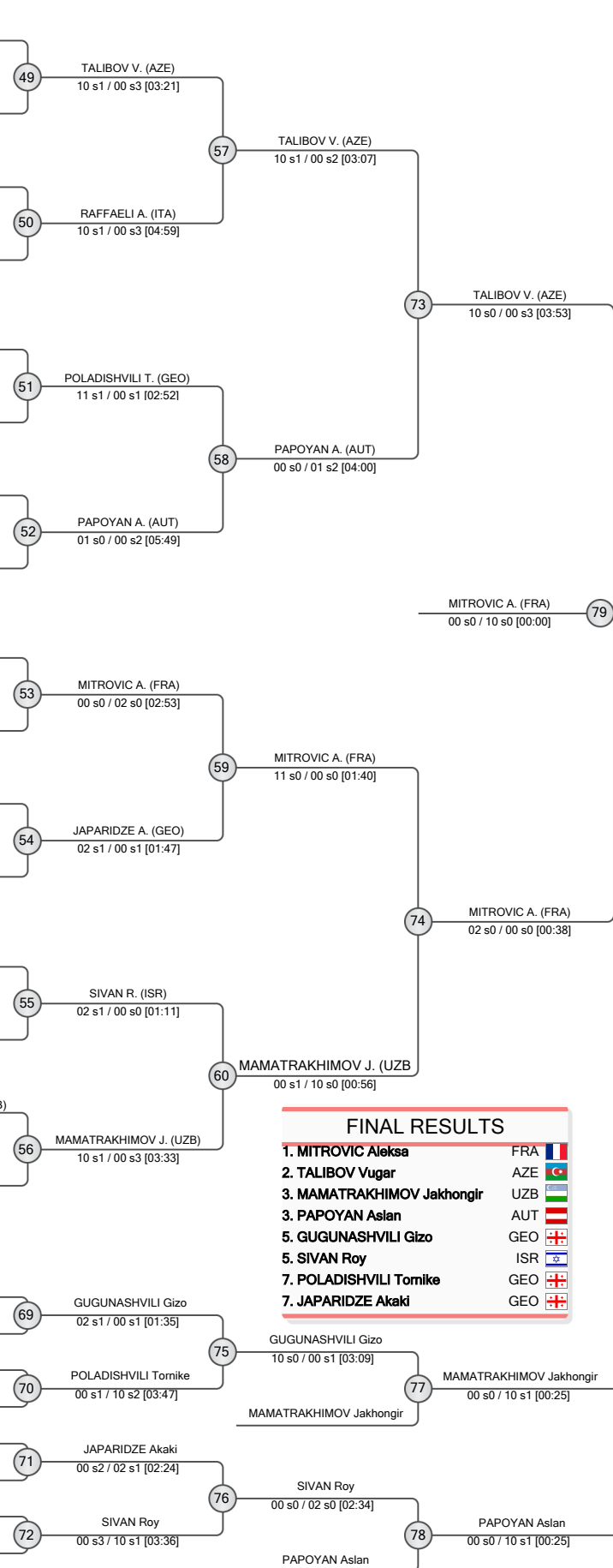

FINAL RESULTS

- MITROVIC Aleksa** (FRA)
- TALIBOV Vugar** (AZE)
- MAMATRAKHIMOV Jakhongir** (UZB)
- PAPOYAN Aslan** (AUT)
- GUGUNASHVILI Gizo** (GEO)
- SIVAN Roy** (ISR)
- POLADISHVILI Tornike** (GEO)
- JAPARIDZE Akaki** (GEO)



Graz Junior European Cup 2022

Austria, Graz, 4-5 Jun 2022

-100 KG

Men (28)

POOL A

	JAPARIDZE Mikheil	GEO
	EDERER Pierre	GER
	NAKANO Tomohiro	JPN
	ANGLIONIN Mathias	FRA
	DUDY David	CZE
	BULTHUIS Silvan	NED
	CILIANI Andrea	ITA

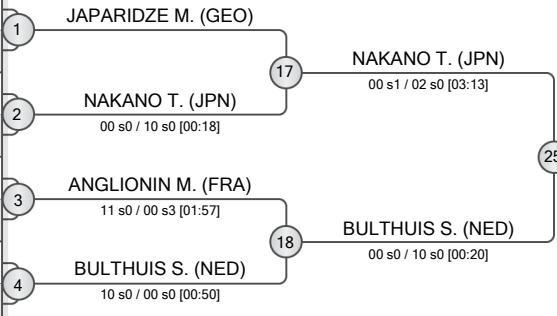

POOL B

	ADAM Viktor	SVK
	AKBASHEV Michael	CAN
	MANSUROV Mukhammadkodir	UZB
	SHUKURBEKOV Zhurkamyrza	KAZ
	AYDAMIROV Rasul	AZE
	SARI Patrik	HUN
	CHAGELISHVILI Zurab	GEO

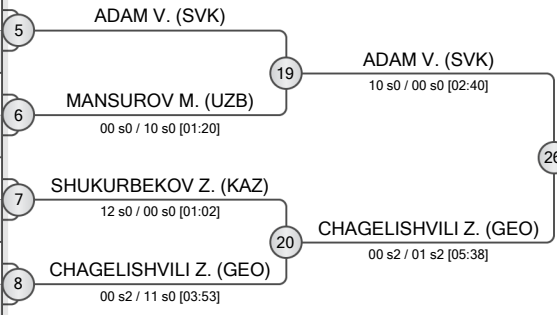

POOL C

	VISSERS Lars	NED
	AKKUS Sidar	TUR
	MGBRISHVILI Lasha	GEO
	PETROVIC Nikola	CAN
	NASIRLI Ruslan	AZE
	NAZYMKHANOV Rauan	KAZ
	GREEN Kaito	JPN

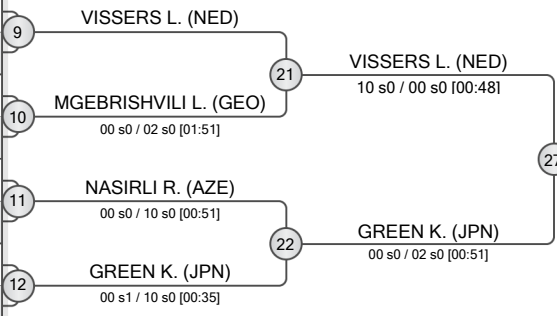

POOL D

	UDSILAURI George	GER
	HAVASI Balint	HUN
	ILLMER Hubert	AUT
	MATASEJE Benjamin	SVK
	BAZIERISHVILI Erekle	GEO
	BASSO Francesco	ITA
	MILLER Gregor	GBR

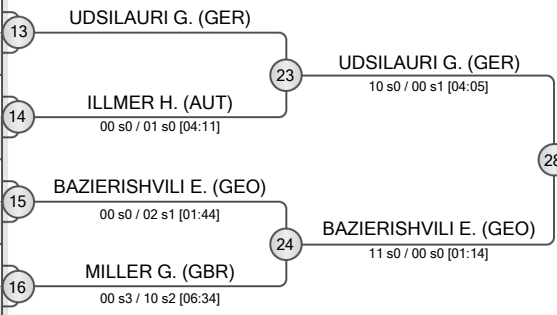

REPECHAGE

EDERER P. (GER)	JAPARIDZE M. (GEO)	29	JAPARIDZE M. (GEO)	33
JAPARIDZE M. (GEO)	BULTHUIS S. (NED)	30	BULTHUIS S. (NED)	34
MANSUROV M. (UZB)	CHAGELISHVILI Z. (GEO)	31	CHAGELISHVILI Z. (GEO)	35
NAZYMKHANOV R. (KAZ)	NASIRLI R. (AZE)	32	NASIRLI R. (AZE)	36
NASIRLI R. (AZE)	ILLMER H. (AUT)	33	ILLMER H. (AUT)	37
ILLMER H. (AUT)	BAZIERISHVILI E. (GEO)	34	BAZIERISHVILI E. (GEO)	38

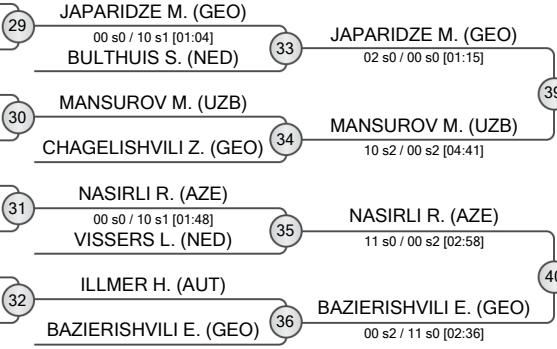

FINAL RESULTS

- GREEN Kaito (JPN)
- NAKANO Tomohiro (JPN)
- UDSILAURI George (GER)
- ADAM Viktor (SVK)
- MANSUROV Mukhammadkodir (UZB)
- BAZIERISHVILI Erekle (GEO)
- JAPARIDZE Mikheil (GEO)
- NASIRLI Ruslan (AZE)





Graz Junior European Cup 2022

Austria, Graz, 4-5 Jun 2022

+100 KG

Men (21)

POOL A

	RAVSHANKULOV Islombek	UZB	1	RAVSHANKULOV I. (UZB)
	KARDAVA Saba	GEO	2	KARDAVA S. (GEO)
	KLEIN Maor	ISR		
	SABIT Kairatbek	KAZ	3	SABIT K. (KAZ)
	JOVIC Luka	AUT	4	JOVIC L. (AUT)

POOL B

	NASIBOV Kanan	AZE	5	NASIBOV K. (AZE)
	RASKA Tomas	CZE	6	RASKA T. (CZE)
	FAGUNDES Vitor	BRA	7	FAGUNDES V. (BRA)
	ALSADUN Mohammed	KSA	8	TABATADZE U. (GEO)
	TABATADZE Ucha	GEO		

POOL C

	DEMETRASHVILI Irakli	GEO	9	DEMETRASHVILI I. (GEO)
	TUTAR Tunahan	TUR	10	UDSILAURI D. (GER)
	UDSILAURI Daniel	GER		
	GURESHIDZE Shalva	GEO	11	GURESHIDZE S. (GEO)
	ALSARI Hussain	KSA	12	KABLAN N. (KAZ)
	KABLAN Nursultan	KAZ		

POOL D

	MESSE A BESSONG John Jr	CAN	13	MESSE A BESSONG J. (CAN)
	SCHONBERGER Mate	HUN	14	TABATADZE G. (GEO)
	TABATADZE Giorgi	GEO		
	MAMMEDOV Huseyn	AZE	15	MAMMEDOV H. (AZE)
	TERESINSKI Grzegorz	POL	16	TERESINSKI G. (POL)

REPECHAGE

	KLEIN M. (ISR)			
	RAVSHANKULOV I. (UZB)	29	RAVSHANKULOV I. (UZB)	33
	ALSADUN M. (KSA)			
	FAGUNDES V. (BRA)	30	FAGUNDES V. (BRA)	34
	KABLAN N. (KAZ)			
	SCHONBERGER M. (HUN)			
	MESSE A BESSONG J. (CAN)	32	MESSE A BESSONG J. (CAN)	36

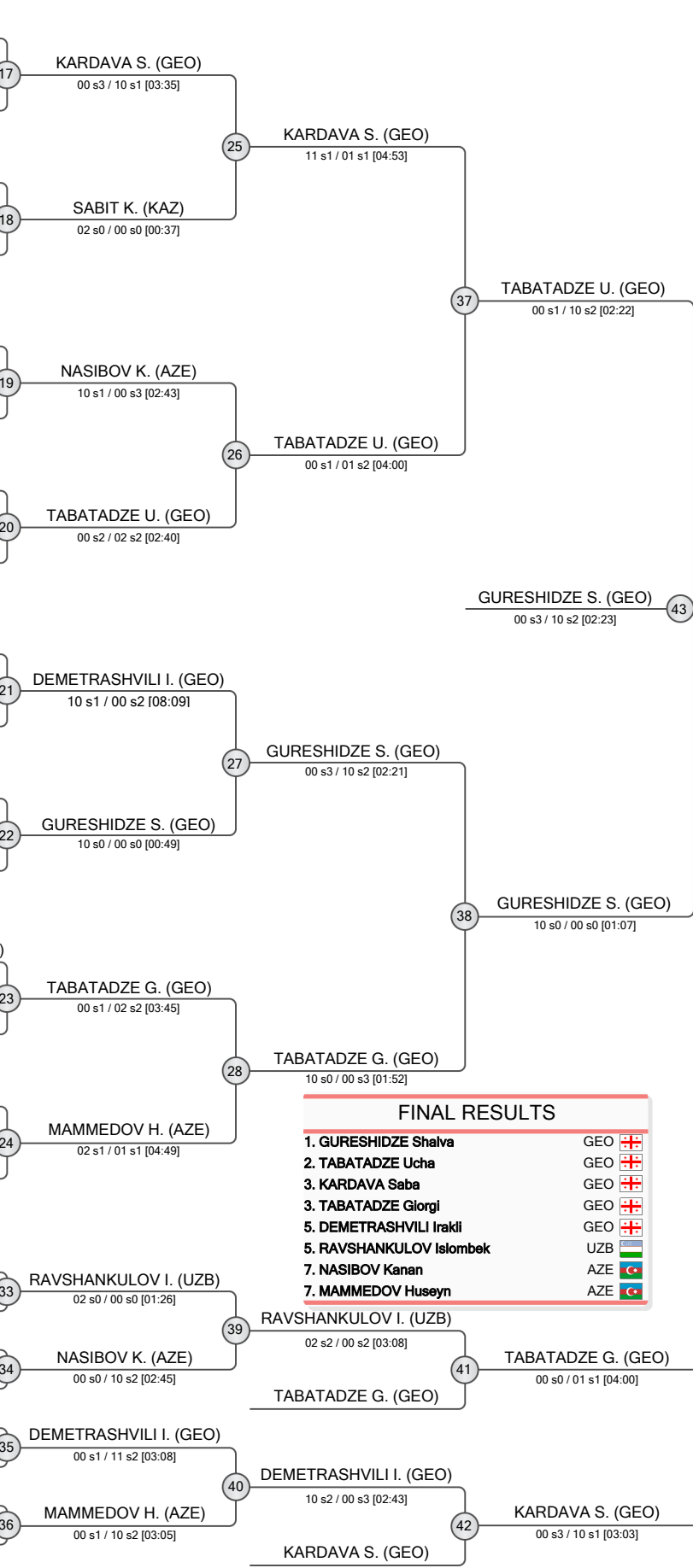

FINAL RESULTS		
1.	GURESHIDZE Shalva	GEO
2.	TABATADZE Ucha	GEO
3.	KARDAVA Saba	GEO
3.	TABATADZE Giorgi	GEO
5.	DEMETRASHVILI Irakli	GEO
7.	RAVSHANKULOV Islombek	UZB
7.	NASIBOV Kanan	AZE
7.	MAMMEDOV Huseyn	AZE





Graz Junior European Cup 2022

Austria, Graz, 4-5 Jun 2022

-48 KG

Women (21)

POOL A

	NASCIMENTO Alexia	BRA
	PEHERSTORFER Lisa	AUT
	DUBOVSKAYA Irina	KAZ
	BODNAROVA Tereza	CZE
	SERDAR Cagla	TUR

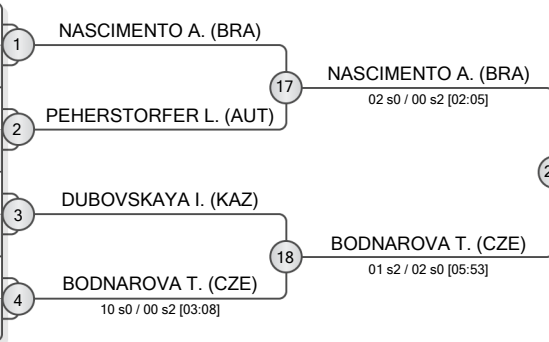

POOL B

	PEREZ SOLER Eva	ESP
	MUNTSUROVA Tanzila	AUT
	GIORGI Giulia	ITA
	RODONAIA Julieta	GEO
	MUMINOVIQ Erza	KOS

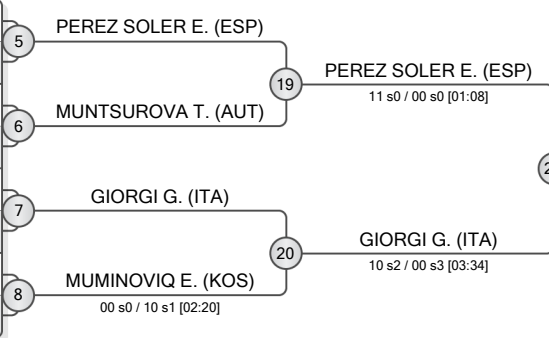

POOL C

	KURBONOVA Khalimajon	UZB
	RIADI Nohade	NED
	KOSZEGI Rebeka Rita	HUN
	GEORGIEVA Aleksa	BUL
	FROEHLICH Verena	AUT

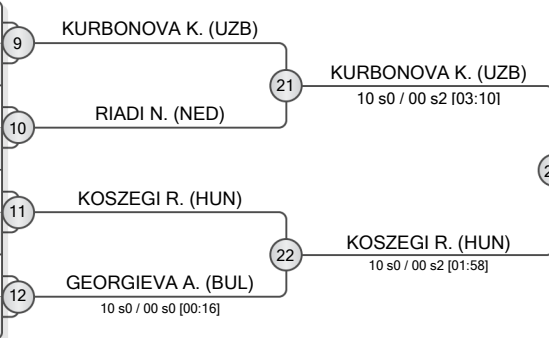

POOL D

	BATISTA Rafaela	BRA
	SHAW Summer	GBR
	KARIAULI Nino	GEO
	VAINSHTEIN Sindi	ISR
	ITO Minaka	JPN
	DUISENBAY Ayana	KAZ

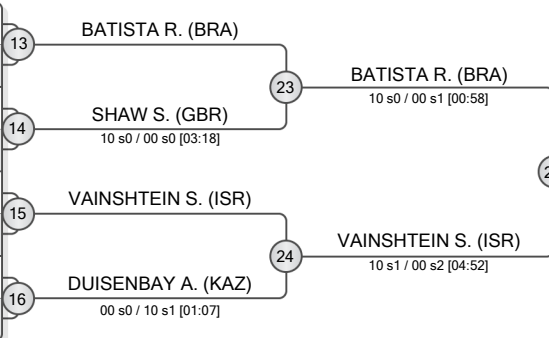

REPECHAGE

29	PEHERSTORFER L. (AUT)
30	MUNTSUROVA T. (AUT)
31	RIADI N. (NED)
32	SHAW S. (GBR)

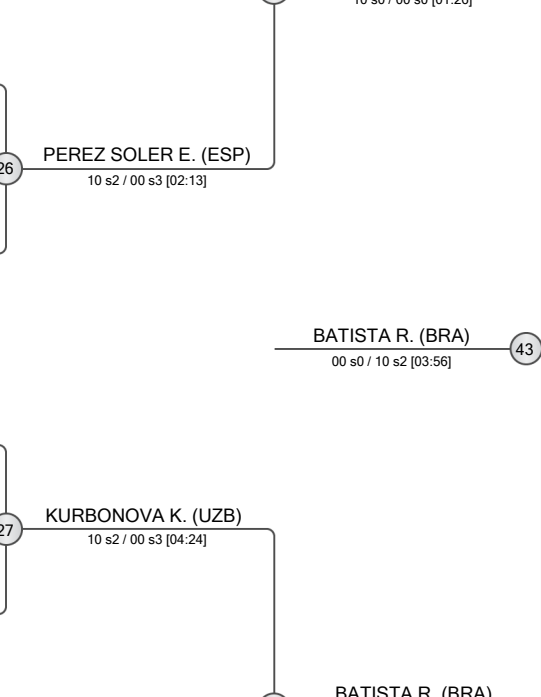

FINAL RESULTS	
1.	BATISTA Rafaela (BRA)
2.	NASCIMENTO Alexia (BRA)
3.	PEREZ SOLER Eva (ESP)
3.	KURBONOVA Khalimajon (UZB)
5.	RIADI Nohade (NED)
5.	BODNAROVA Tereza (CZE)
7.	GIORGI Giulia (ITA)
7.	VAINSHTEIN Sindi (ISR)





Graz Junior European Cup 2022

Austria, Graz, 4-5 Jun 2022

-52 KG

Women (23)

POOL A

	CARNA Giulia	ITA
	BEATON Evelyn	CAN
	PEREZ PACHECO Veronica	ESP
	LAVY Ruth	ISR
	AMANN Fanny	AUT
	BADICEANU Florina	ROU

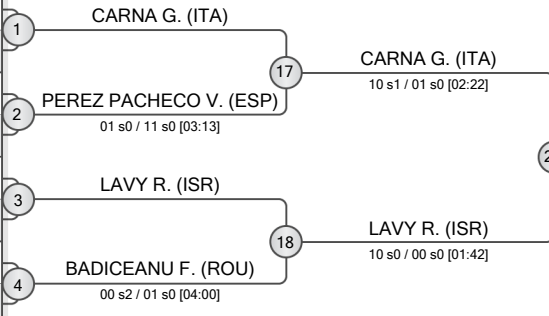

POOL B

	KELLER Rebeka	HUN
	TSIKLAURI Elene	GEO
	HOEPS Aurelia Moira, GER	GER
	YEREZHEPOVA Aruzhan	KAZ
	ABDELKRIM Nawel	FRA
	GADERMAIER Katja	AUT

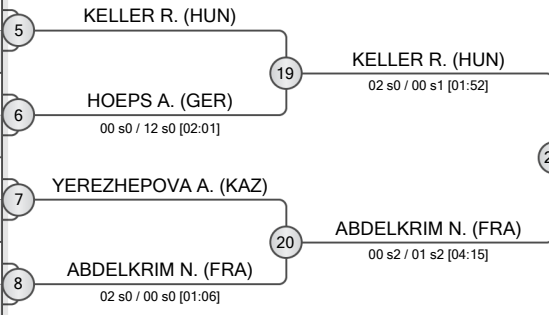

POOL C

	CASTELLO DIEZ Marina	ESP
	POTSKHVERASHVILI Mariami	GEO
	SICKINGER Larissa	AUT
	PASCA Alexandra	ROU
	SHIOHARA Mimi	JPN

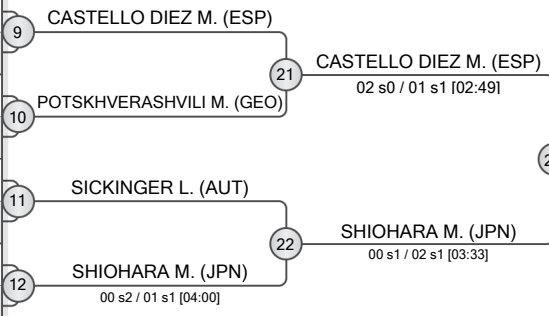

POOL D

	RAAB Yarden	ISR
	MAMIRA Luca	HUN
	GUES Safeine	FRA
	NISAVIC Nikolina	SRB
	MARTINER Melanie	AUT
	KOCYIGIT Ilayda Merve	TUR

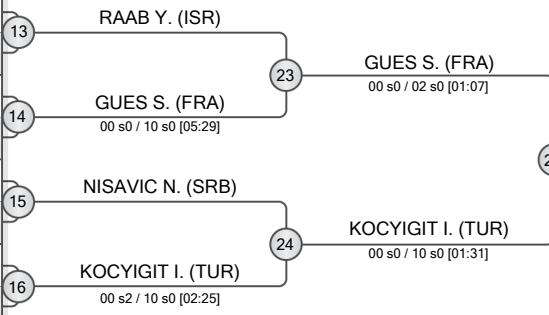

REPECHAGE

PEREZ PACHECO V. (ESP)	29	PEREZ PACHECO V. (ESP)	
GADERMAIER K. (AUT)		LAVY R. (ISR)	33
YEREZHEPOVA A. (KAZ)	30	YEREZHEPOVA A. (KAZ)	34
PASCA A. (ROU)		KELLER R. (HUN)	
SICKINGER L. (AUT)	31	PASCA A. (ROU)	35
MARTINER M. (AUT)		CASTELLO DIEZ M. (ESP)	
NISAVIC N. (SRB)	32	NISAVIC N. (SRB)	36
		GUES S. (FRA)	

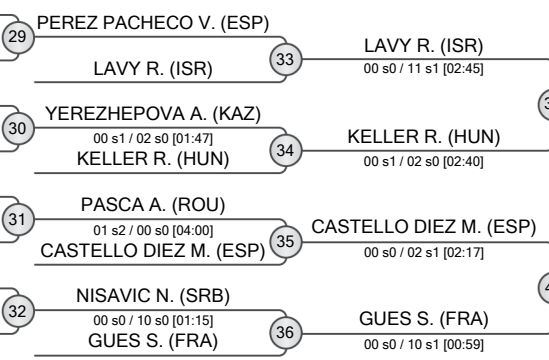

FINAL RESULTS	
1.	CARNA Giulia (ITA)
2.	KOCYIGIT Ilayda Merve (TUR)
3.	SHIOHARA Mimi (JPN)
3.	CASTELLO DIEZ Marina (ESP)
5.	LAVY Ruth (ISR)
5.	ABDELKRIM Nawel (FRA)
7.	KELLER Rebeka (HUN)
7.	GUES Safeine (FRA)

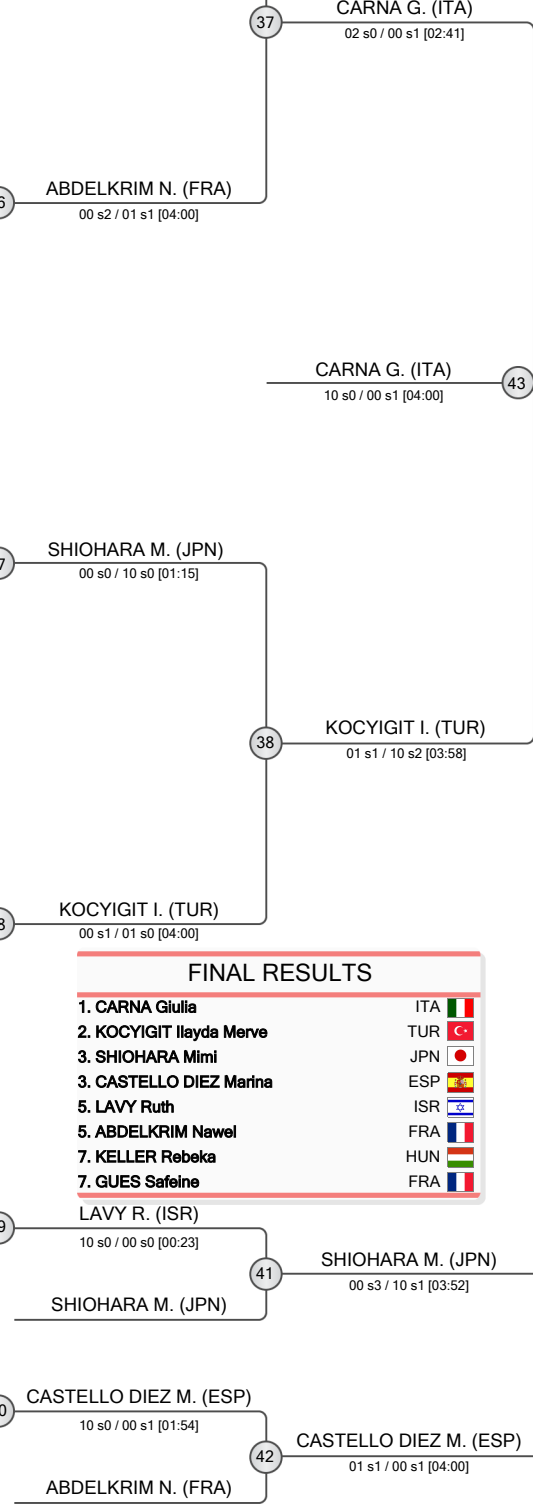

POOL A

	HENNINGER Elin	NED	1
	DARIDA Blanka	HUN	2
	BUDAK Aysenur	TUR	3
	DORI Romi	ISR	4
	WAKUP Nehle	GER	5
	KASAPI Fatona	KOS	6
	ALEXANDER Eibhleann	CAN	7
	LOLADZE Nino	GEO	8
	KONARE SISSOKO Deniba	ESP	9
	NITSCHKE Shenna	GER	10
	BAMBERGER Julia	AUT	11

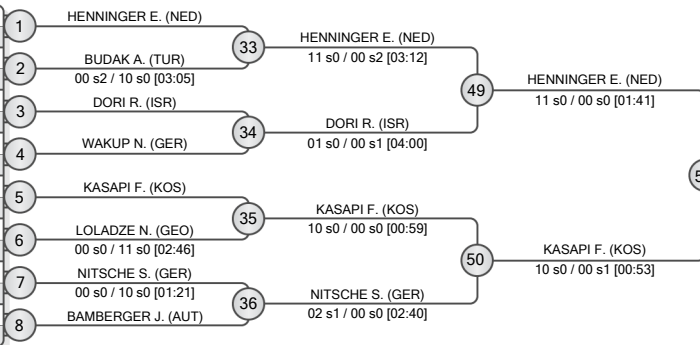

POOL B

	AVANZATO Carlotta	ITA	9
	KARLSSON Hillevi	SWE	10
	SOKIRJANSKA Anastasija	LAT	11
	BRAND Kyra	GER	12
	BORDINSKYKH Sofiia	UKR	13
	BEISENOVA Moldir	KAZ	14
	OLDAK Alicja	POL	15
	NDIAYE Binta	SUI	16
	MARTIN GIL Alicia	ESP	17
	FUEREDER Hannah	AUT	18

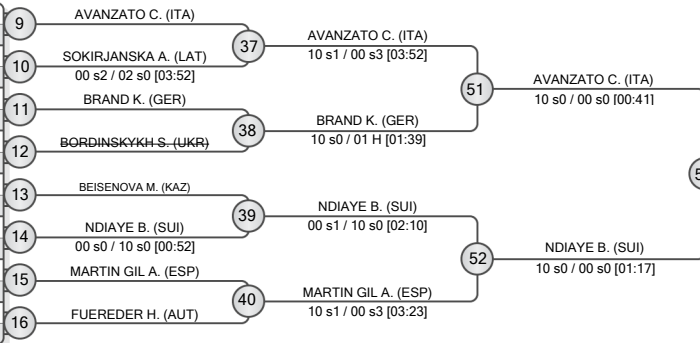

POOL C

	GARCIA MARTIN Marta	ESP	17
	GRANUDD Felicia	SWE	18
	KARADAG Aysenur	TUR	19
	BEURSKENS Julie	NED	20
	ROZAN Maylis	FRA	21
	ZUCCARO Chiara	ITA	22
	HIDEN Verena	AUT	23
	BURZENADZE Mariam	GEO	24
	WENDAV Cheyenne Lea	GER	25
	BJOERAAS Elise	NOR	26

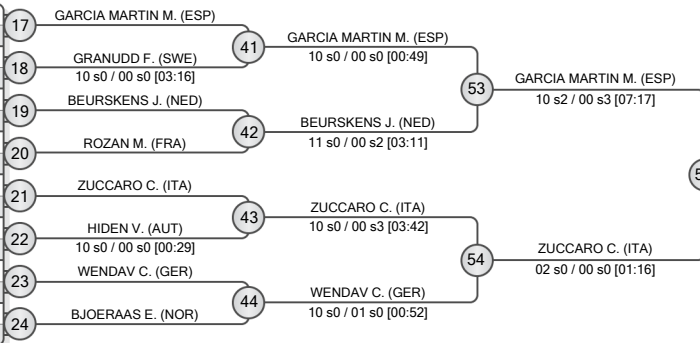

POOL D

	AMINOVA Shukurjon	UZB	25
	KARAS Kondelia	CAN	26
	CAPANNI DIAS Thauany David	ITA	27
	NURM Anna Liisa	EST	28
	LAUBER Natascha	GER	29
	CANCELA Tasha	USA	30
	RODRIGUEZ SALVADOR Adri	ESP	31
	ROSSET Aline	SUI	32
	LIPPERT Sarah	AUT	33
	GJAKOVA Debora	KOS	34
	EGUCHI Rin	JPN	35

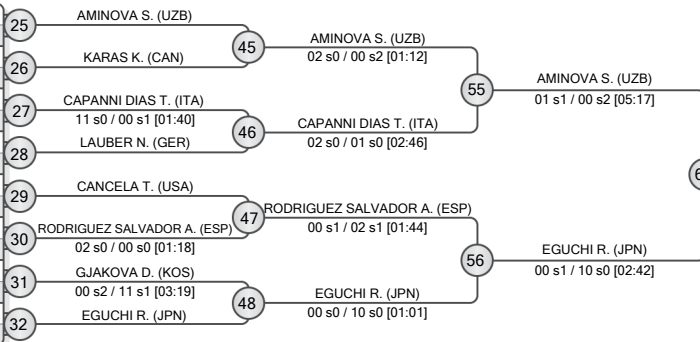

1.	EGUCHI Rin	JPN	
2.	NDIAYE Binta	SUI	
3.	ZUCCARO Chiara	ITA	
5.	AMINOVA Shukurjon	UZB	
5.	AVANZATO Carlotta	ITA	
5.	KASAPI Fatona	KOS	
7.	HENNINGER Elin	NED	
7.	HIDEN Verena	AUT	

REPECHAGE

61	LOLADZE Nino	65	LOLADZE Nino
62	NITSCHKE Shenna	66	BEISENOVA Moldir
63	BEISENOVA Moldir	67	HIDEN Verena
64	MARTIN GIL Alicia	68	WENDAV Cheyenne Lea
64	HIDEN Verena	68	GJAKOVA Debora
64	WENDAV Cheyenne Lea	68	RODRIGUEZ SALVADOR Adriana

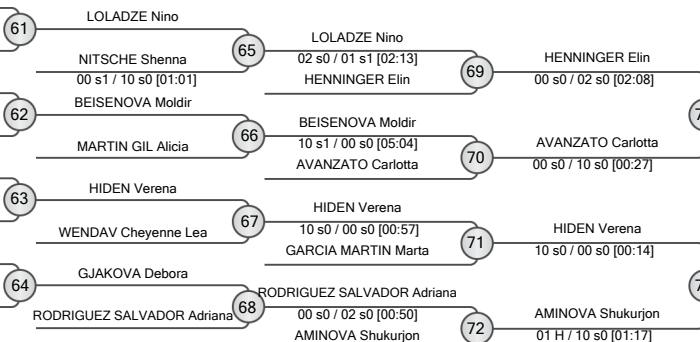

77	ZUCCARO Chiara	78	AMINOVA Shukurjon
77	ZUCCARO Chiara	78	KASAPI Fatona



Graz Junior European Cup 2022

Austria, Graz, 4-5 Jun 2022

-63 KG

Women (37)

POOL A

	VAN LIESHOUT Joanne	NED	1	VAN LIESHOUT J. (NED)	
	FRIDEN Chiara	SUI	2	FRIDEN C. (SUI)	33
	ANDERSSON Ella	SWE	3	ANDERSSON E. (SWE)	
	VIT Lili	HUN	4	VIT L. (HUN)	34
	AFYONLU Habibe	TUR	5	AFYONLU H. (TUR)	
	FIZELOVA Ema	SVK	6	WOESS R. (AUT)	35
	WOESS Rosalie	AUT		00 s3 / 10 s0 [04:51]	
	GALLUDEC Clara	FRA	7	GALLUDEC C. (FRA)	
	CORBO Sara	ITA	8	CORBO S. (ITA)	36
				00 s0 / 02 s0 [03:19]	

POOL B

	NALBAT Kamile	NED	9	NALBAT K. (NED)	
	ISHIOKA Kurumi	JPN	10	ISHIOKA K. (JPN)	37
	EKOSKY Sarah	CAN	11	EKOSKY S. (CAN)	
	DOLIDZE Tamuna	GEO	12	SIMIC N. (CRO)	38
	SIMIC Nina	CRO		00 s0 / 10 s0 [00:47]	
	REDJEPOVA Farangiz	UZB	13	REDJEPOVA F. (UZB)	
	KUCHAVA Iia	UKR	14	NOVITZKI A. (ISR)	39
	NOVITZKI Adelina	ISR		00 s1 / 11 s0 [02:33]	
	KRAFT Pia-Jacqueline	AUT	15	KRAFT P. (AUT)	
	ZUCCO Agnese	ITA	16	ZUCCO A. (ITA)	40
				00 s0 / 10 s0 [00:59]	

POOL C

	KUYULOVA Esmigul	KAZ	17	KUYULOVA E. (KAZ)	
	MACDONALD Meadow	CAN	18	MACDONALD M. (CAN)	41
	KONFISZ Amelia	POL	19	KONFISZ A. (POL)	
	FERENCZ Virag	HUN	20	NISAVIC K. (SRB)	42
	NISAVIC Kristina	SRB		00 s2 / 10 s0 [04:34]	
	PALUMBO Antonietta	ITA	21	PALUMBO A. (ITA)	
	SCHUSTER Kaja	SLO	22	SCHUSTER K. (SLO)	43
	POULAIN Juliette	FRA	23	POULAIN J. (FRA)	
	RITTSTEIGER Mathilda	AUT	24	RITTSTEIGER M. (AUT)	44
				10 s0 / 00 s1 [02:26]	

POOL D

	LISCIANI Sara	ITA	25	LISCIANI S. (ITA)	
	SKALSKA Anna	CZE	26	SKALSKA A. (CZE)	45
	IVANESCU Florentina	ROU	27	IVANESCU F. (ROU)	
	VON LEUPOLDT Charlotte	GER	28	ASKILASHVILI E. (GEO)	46
	ASKILASHVILI Eter	GEO		00 s0 / 10 s0 [01:33]	
	DINIZ Maria	BRA	29	DINIZ M. (BRA)	
	KALLINGER Laura	AUT	30	KALLINGER L. (AUT)	47
	WESTLAKE Kiera	CAN	31	WESTLAKE K. (CAN)	
	COHEN UDI Yuval	ISR	32	COHEN UDI Y. (ISR)	48
				00 s0 / 10 s0 [00:38]	

REPECHAGE

	FRIDEN Chiara	61	FRIDEN Chiara	65	FRIDEN Chiara	69
	VIT Lili		VIT Lili		VIT Lili	
	NALBAT Kamile	62	NALBAT Kamile	66	NALBAT Kamile	70
	SIMIC Nina		SIMIC Nina		SIMIC Nina	
	MACDONALD Meadow	63	MACDONALD Meadow	67	MACDONALD Meadow	71
	NISAVIC Kristina		NISAVIC Kristina		NISAVIC Kristina	
	KALLINGER Laura	64	KALLINGER Laura	68	KALLINGER Laura	72
	COHEN UDI Yuval		COHEN UDI Yuval		COHEN UDI Yuval	

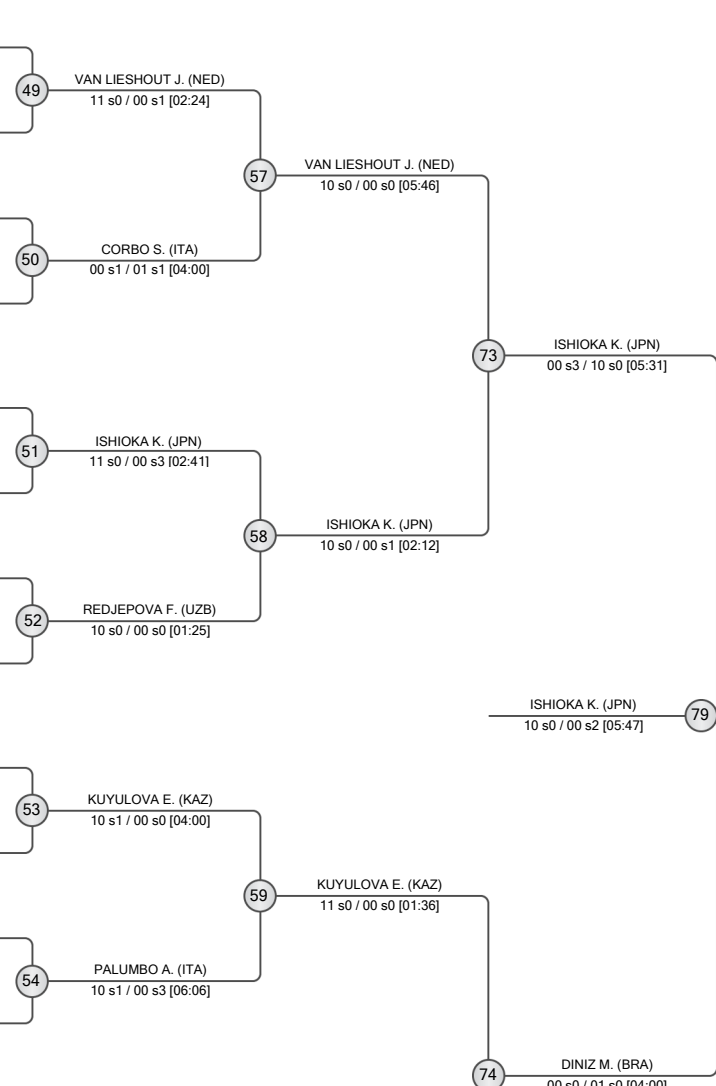

FINAL RESULTS		
1.	ISHIOKA Kurumi	JPN
2.	DINIZ Maria	BRA
3.	KUYULOVA Esmigul	KAZ
3.	VAN LIESHOUT Joanne	NED
5.	CORBO Sara	ITA
5.	PALUMBO Antonietta	ITA
7.	NALBAT Kamile	NED
7.	KALLINGER Laura	AUT





Graz Junior European Cup 2022

Austria, Graz, 4-5 Jun 2022

-70 KG

Women (29)

POOL A

	SOBIERAJSKA Katarzyna	POL
	FRANZOSI Ludovica	ITA
	MIZOGUCHI Aoi	JPN
	BIRON Laurence	CAN
	PUHALJ Brina	SLO
	BAYER Corinna	GER
	RYTSKA Mariia	UKR

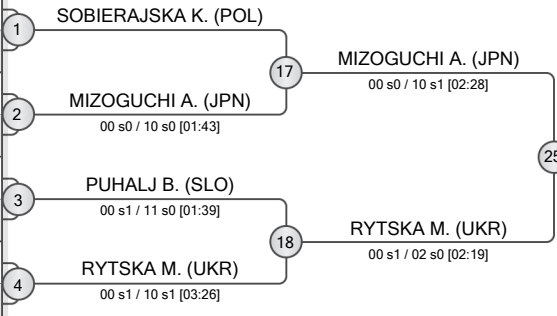

POOL B

	INSUA IGLESIAS Noelia	ESP
	JAKOBSEN Ida	DEN
	BUDDENKOTTE Eva Ronja	GER
	KOLAR Stasa, SLO	SLO
	VAN WONDEREN Dagmar	NED
	SEDLMAIR Hanna	GER
	DESANGLE Marie	FRA
	MALKA Avia	ISR

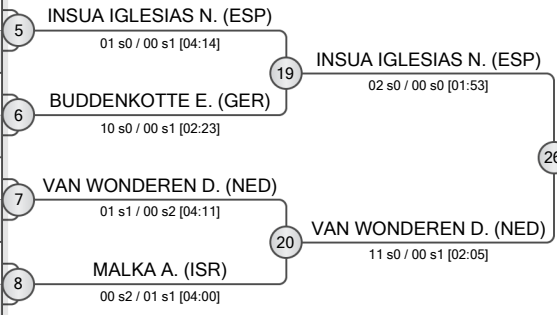

POOL C

	EGAMBERGANOVA Shakhlo	UZB
	JOHNSSON Liv	SWE
	BRANCHEVA Lidia	BUL
	GRUENEWALD Tanja	GER
	GULBANI Nino	GEO
	KOREN Nika	SLO
	TSIMKO Olga	UKR

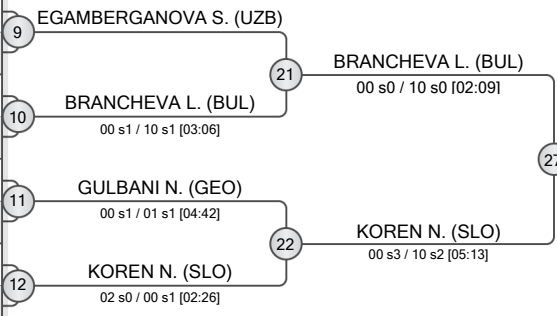

POOL D

	NYSSANTAIKYZY Roza	KAZ
	THIELE Jenna	GER
	KOVACS Viktoria	HUN
	KOGAN Maya	ISR
	VANDEMIR Hatice	TUR
	MAZOVEC Ursula	SLO
	HOSHINO Nanako	JPN

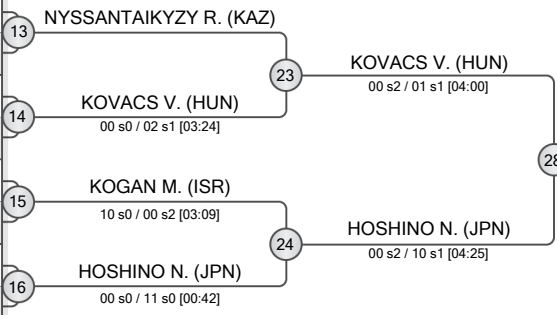

FINAL RESULTS		
1.	HOSHINO Nanako	JPN
2.	INSUA IGLESIAS Noelia	ESP
3.	KOREN Nika	SLO
3.	KOGAN Maya	ISR
5.	SOBIERAJSKA Katarzyna	POL
5.	MIZOGUCHI Aoi	JPN
7.	VAN WONDEREN Dagmar	NED
7.	BRANCHEVA Lidia	BUL

REPECHAGE

FRANZOSI L. (ITA)	29	SOBIERAJSKA K. (POL)	33	SOBIERAJSKA K. (POL)
SOBIERAJSKA K. (POL)		RYTSKA M. (UKR)		
JAKOBSEN I. (DEN)	30	BUDDENKOTTE E. (GER)	34	VAN WONDEREN D. (NED)
BUDDENKOTTE E. (GER)		VAN WONDEREN D. (NED)		
TSIMKO O. (UKR)	31	GULBANI N. (GEO)	35	BRANCHEVA L. (BUL)
GULBANI N. (GEO)		BRANCHEVA L. (BUL)		
MAZOVEC U. (SLO)	32	KOGAN M. (ISR)	36	KOGAN M. (ISR)
KOGAN M. (ISR)		KOVACS V. (HUN)		

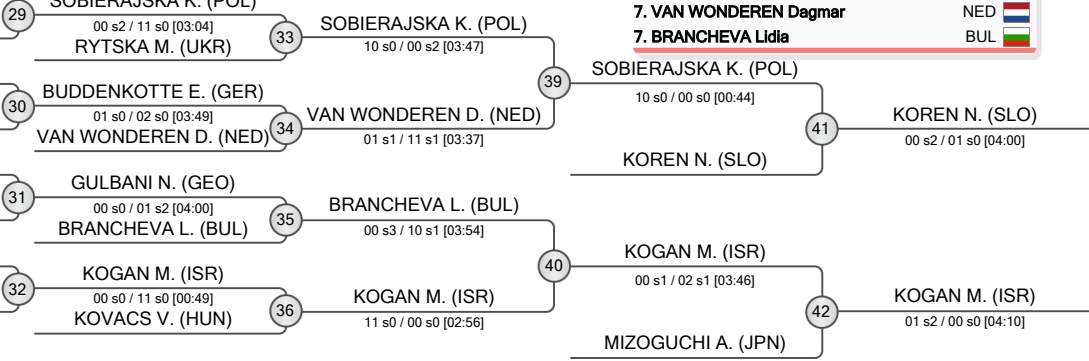

POOL A

	OLEK Anna-Monta	GER
	JAKUS Nika	CRO
	VERSMISSE Lyse	FRA
	KAZAKOVA Anna	UKR
	PETKOVA Veronika	BUL

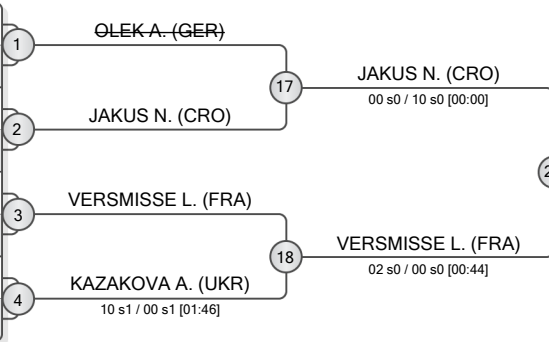

POOL B

	FREITAS Beatriz	BRA
	KURODA Aki	JPN
	KURBANBAEVA Iriskhon	UZB
	JANJIC Tara	SLO
	MUSZYNSKA Paulina	POL

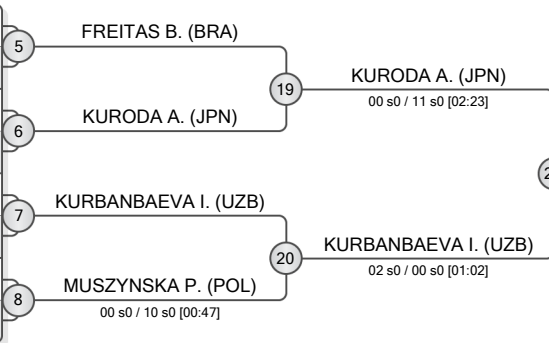

POOL C

	RAMOS Eliza	BRA
	MENGUCCI Carolina	ITA
	RUBIANO Morgane	FRA
	MICHAILIDOU Zanet	CYP
	KOPITAR STURM Tea	SLO
	NIEMEYER Mathilda Sophie	GER

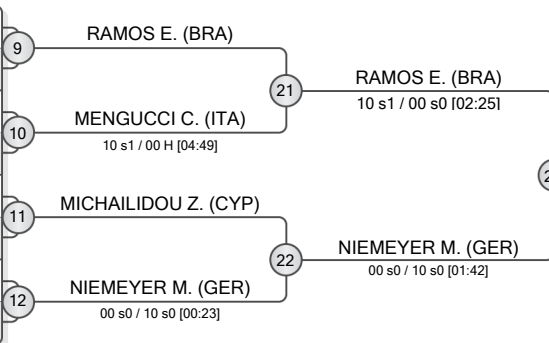

POOL D

	DERKS Lieke	NED
	KURCHENKO Yuliia	UKR
	ZLATIN Slata	GER
	MISHINER Yuli Alma	ISR
	KAYA Sumeyye	TUR

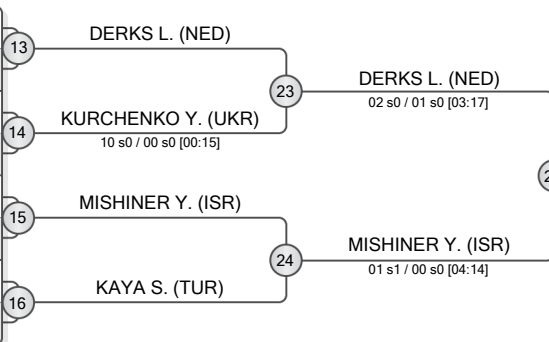

REPECHAGE

29 KAZAKOVA A. (UKR)	30 FREITAS B. (BRA)	31 MENGUCCI C. (ITA)	32 KURCHENKO Y. (UKR)
33 JAKUS N. (CRO)	34 KURBANBAEVA I. (UZB)	35 NIEMEYER M. (GER)	36 MISHINER Y. (ISR)

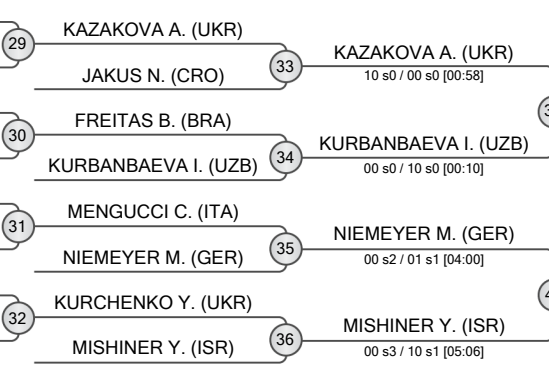

43 KURODA A. (JPN) 01 s1 / 00 s2 [04:00]

FINAL RESULTS	
1. KURODA Aki	
2. DERKS Lieke	
3. RAMOS Eliza	
3. VERSMISSE Lyse	
5. KAZAKOVA Anna	
5. MISHINER Yuli Alma	
7. KURBANBAEVA Iriskhon	
7. NIEMEYER Mathilda Sophie	

POOL A

- TAKIYEVA Karina (KAZ) 1
- DIRGEN Duygu (TUR) 2
- DIARRASSOUBA Oceane (FRA) 2

POOL B

- KURAMBOEVA Fotima (UZB) 3
- TOISHIBEKOVA Aida (KAZ) 4
- DIACENCO Oxana (MDA) 4

POOL C

- DIJKSTRA Carmen (NED) 5
- MARINI Tiziana (ITA) 6
- MUKUNOKI Miki (JPN) 6

POOL D

- OLIVEIRA Luana (BRA) 7
- SIMONETTI Erica (ITA) 8
- MACHUT Lea (FRA) 8

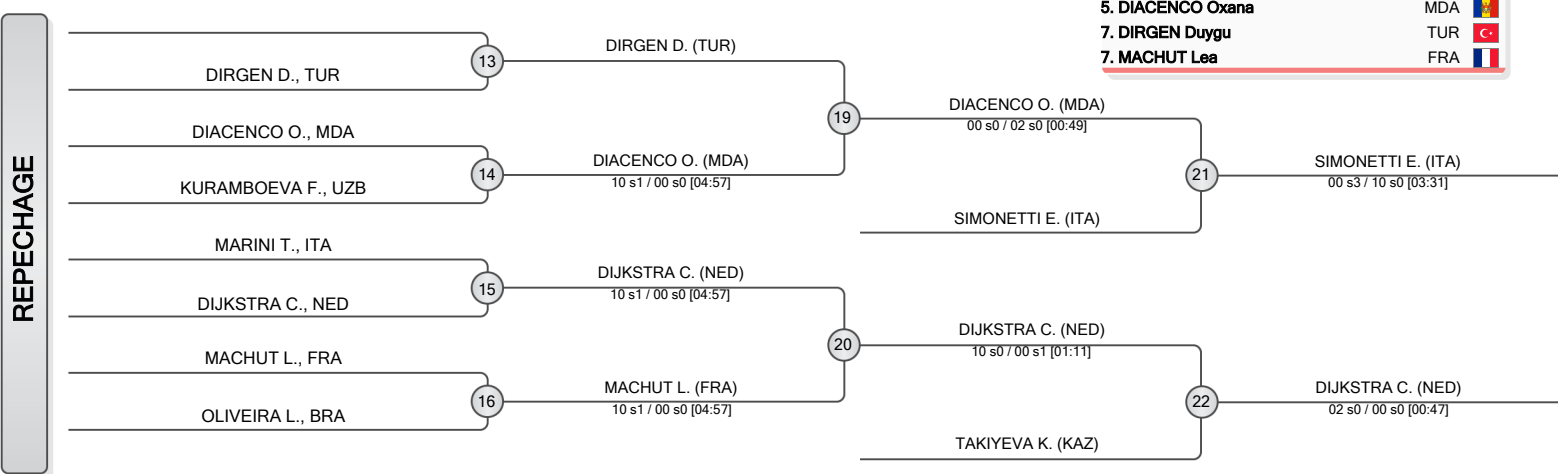

FINAL RESULTS		
1. MUKUNOKI Miki	JPN	
2. TOISHIBEKOVA Aida	KAZ	
3. DIJKSTRA Carmen	NED	
3. SIMONETTI Erica	ITA	
5. TAKIYEVA Karina	KAZ	
5. DIACENCO Oxana	MDA	
7. DIRGEN Duygu	TUR	
7. MACHUT Lea	FRA	